

Sefa























































HEAT TRANSFER TECHNOLOGIES

Transfer Presses - Large Format Presses - Accessories













Chemica | Stilscreen | Sefa | Elms | TransferID | Sporting ID

TECHNICAL SPECS

Clam Presses											
CLAM ONE ^{V3}	✓			✓	✓	✓	✓	✓	✓		
CLAM PRO ^{V3}	✓	✓		✓	✓	✓	✓				✓
Swing Presses											
ROTEX ONE ^{V4}	✓			✓	✓	✓	✓				✓
ROTEX LITE ^{V4}	✓	✓		✓	✓	✓	✓				✓
ROTEX PRO ^{V4}	✓	✓		✓	✓	✓	✓	✓			✓
ROTEX AIR LITE ^{V3}	✓		✓	✓	✓	✓	✓				✓
ROTEX AIR PRO ^{V3}	✓		✓	✓	✓	✓	✓	✓			✓
Dual Plate Presses											
DUPLEX LITE ^{V3}	✓		✓	✓	✓	✓	✓	✓	✓		
DUPLEX PRO ^{V3}	✓		✓	✓	✓	✓	✓	✓	✓	✓	
DUPLEX AIR PRO ^{V3}	✓		✓	✓	✓	✓	✓	✓	✓	✓	✓
DUPLEX MINI PRO ^{V3}	✓		✓	✓	✓	✓			✓	✓	
Logo & Sport Presses											
LM 130 REL ^{V3}	✓			✓	✓	✓					✓
LE 130 L ^{V3}	✓	✓		✓	✓	✓					✓
LP 130 T ^{V3}	✓		✓	✓	✓	✓				✓	✓
CLAM SPORT ^{V3}	✓	✓		✓	✓	✓					✓
SLIDE for Textile											
SLIDE 540 LITE	✓		✓	✓	✓	✓					✓
SLIDE 540 PRO	✓		✓	✓	✓	✓		✓			✓

Legend

 Touch screen	 Electro magnetic	 Pneumatic	 2-year warranty	 10-year warranty for heating elements	
 Programs	 Quick release	 GPX 3200W	 Eco mode	 Foot pedal	 Membrane system

GENERAL INSTRUCTIONS FOR USE - Due to the variety of substrates, their treatments and the conditions of application, which are beyond our control, trials must be made before each use.



CLAM ONE V3



CLAM PRO V3

	CLAM ONE V3
Weight	44 Kg
Pressure	254 gr/cm ²
Max temperature	220°C
Power supply	240V single phase
Electric power	2500 W
Amperage	11 A
Plate	40x50 cm
Dimensions (HxLxW)	857x742x455 mm
Packing	CAI-NO3
Features	Manual closing Manual opening

	CLAM PRO V3
Weight	58 Kg
Pressure	330 gr/cm ²
Max temperature	220°C
Power supply	240V single phase
Electric power	3200 W
Amperage	14 A
Plate	40x50 cm
Dimensions (HxLxW)	969x990x453 mm
Packing	CAI-O11
Features	Automatic opening Manual drawer

CLAM PRESSES



ROTEX PRO V4

	ROTEX ONE V4	ROTEX LITE V4	ROTEX PRO V4
Weight	80 Kg	81 Kg	81 Kg
Pressure	590 gr/cm ²	590 gr/cm ²	590 gr/cm ²
Max temperature	220°C	220°C	220°C
Power supply	240V single phase	240V single phase	240V single phase
Electric power	2500 W	2500 W	3200 W
Amperage	11 A	11 A	14 A
Plate	40x50cm	40x50 cm	40x50 cm
Dimensions (HxLxW)	759x909x569 mm	759x909x569 mm	759x909x594 mm
Packing	CAI-O11	CAI-O11	CAI-O11
Features	Manual opening Manual swing	Automatic opening Manual swing	Automatic opening Automatic swing

ROTEX SWING PRESSES

	ROTEX AIR LITE V3	ROTEX AIR PRO V3
Weight	81 Kg	81 Kg
Pressure	400 gr/cm ²	400 gr/cm ²
Max temperature	220°C	220°C
Power supply	240V single phase	240V single phase
Electric power	2500 W	3200 W
Amperage	11 A	14 A
Plate	40x50cm	40x50 cm
Dimensions (HxLxW)	621x847x572 mm	621x847x597 mm
Packing	CAI-O11	CAI-O11
Features	Automatic opening Automatic closing Manual swing Compressed air required	Automatic opening Automatic closing Automatic swing Compressed air required



ROTEX AIR PRO V3

DUPLEX PRO V3



DUPLEX MINI PRO



	DUPLEX LITE V3	DUPLEX PRO V3	DUPLEX AIR PRO V3	DUPLEX MINI PRO
Weight	158 Kg	170 Kg	193 Kg	60 Kg
Pressure	625 gr/cm ²	625 gr/cm ²	625 gr/cm ²	993 gr/cm ²
Max temperature	220°C	220°C	220°C	220°C
Power supply	240V single phase	240V single phase	240V single phase	240V single phase
Electric power	3200 W	3200 W	3200 W	600 W
Amperage	14 A	14 A	14 A	3 A
Plate	40x50 cm	40x50 cm	40x50 cm	Not included
Dimensions (HxLxW)	713x891x1079 mm	713x891x1079 mm	713x891x1079 mm	625x646x941 mm
Packing	CAI-DU-PRO	CAI-DU-PRO	CAI-DU-PRO	CAI-009
Features	Automatic opening Automatic closing Manual swing Compressed air required	Automatic opening Automatic closing Automatic swing Compressed air required	Automatic opening Automatic closing Automatic swing Membrane plate Compressed air required	Automatic opening Automatic closing Manual swing Compressed air required

DUPLEX DUAL PLATE PRESSES

LP 130 T



	LM 130 REL V3	LE 130 L V3	LP 130 T V3
Weight	19 Kg	22 Kg	25 Kg
Pressure	600 gr/cm ²	600 gr/cm ²	940 gr/cm ²
Max temperature	220°C	220°C	220°C
Power supply	240V single phase	240V single phase	240V single phase
Electric power	400 W	400 W	400 W
Amperage	2 A	2 A	2 A
Plate	13x13cm	13x13 cm	13x13 cm
Dimensions (HxLxW)	621x549x233 mm	621x549x233 mm	498x544x274 mm
Packing	AMERICAN	AMERICAN	AMERICAN
Features	Manual opening Manual closing	Automatic opening Manual closing	Automatic opening Automatic closing Compressed air required

LOGO & SPORT PRESSES

CLAM SPORT V3

Weight	24 Kg
Max temperature	220°C
Power supply	240V single phase
Electric power	600 W
Amperage	3 A
Plate	Not included
Dimensions (HxLxW)	899x503x263 mm
Packing	CAI-SPORT
Features	Automatic opening





	SLIDE 540 LITE/PRO	SLIDE 655 LITE/PRO
Weight	82.5 Kg	115 Kg
Pressure	363 gr/cm ²	363 gr/cm ²
Max temperature	220°C	220°C
Power supply	240V	240V
Electric power	3200 W	3200 W
Amperage	14 A	14 A
Plate	40x50 cm	64x54 cm
Working area	-	60x50 cm
Dimensions (HxLxW)	486x880x728mm	665x722x870 mm
Packing	CAI-DU-PRO	CAI-DU-PRO
Features	Automatic opening Automatic closing Manual drawer LITE Automatic drawer PRO 1 heating zone	Automatic opening Automatic closing Manual drawer LITE Automatic drawer PRO 1 heating zone

	SLIDE 865	SLIDE 1285
Weight	261 Kg	419 Kg
Pressure	453 gr/cm ²	386 gr/cm ²
Max temperature	255°C	255°C
Power supply	240V single phase	400V 3 phases
Electric power	6000 W	12000 W
Amperage	28 A	18 A
Plate	85x65 cm	125x85 cm
Working area	80x60 cm	120x80 cm
Dimensions (HxLxW)	794x1756x893 mm	794x2153x1286 mm
Packing	CAI-SLIDE	CAI-SLIDE
Features	Automatic opening Automatic closing Manual drawer 2 heating zones	Automatic opening Automatic closing Manual drawer 2 heating zones



	SUBLI 1510 +
Weight	1000 Kg
Pressure	296 gr/cm ²
Max temperature	220°C
Power supply	400V 3 phases
Electric power	20250 W
Amperage	32 A
Plate	157x107 cm
Working area	152x102 cm
Dimensions (HxLxW)	1370x2740x2019 mm
Packing	CAI-SUBLI
Features	Automatic opening Automatic closing Automatic drawing 2 Plates 2 heating zones

	SUBLIMAXI 2513
Weight	2180 Kg
Pressure	318 gr/cm ²
Max temperature	220°C
Power supply	400V 3 phases
Electric power	35000 W
Amperage	56 A
Plate	255x130 cm
Working area	250x125 cm
Dimensions (HxLxW)	1446x3202x3007 mm
Packing	CAI-SUBLI-2513
Features	Automatic opening Automatic closing Automatic drawer 2 Plates 4 heating zone

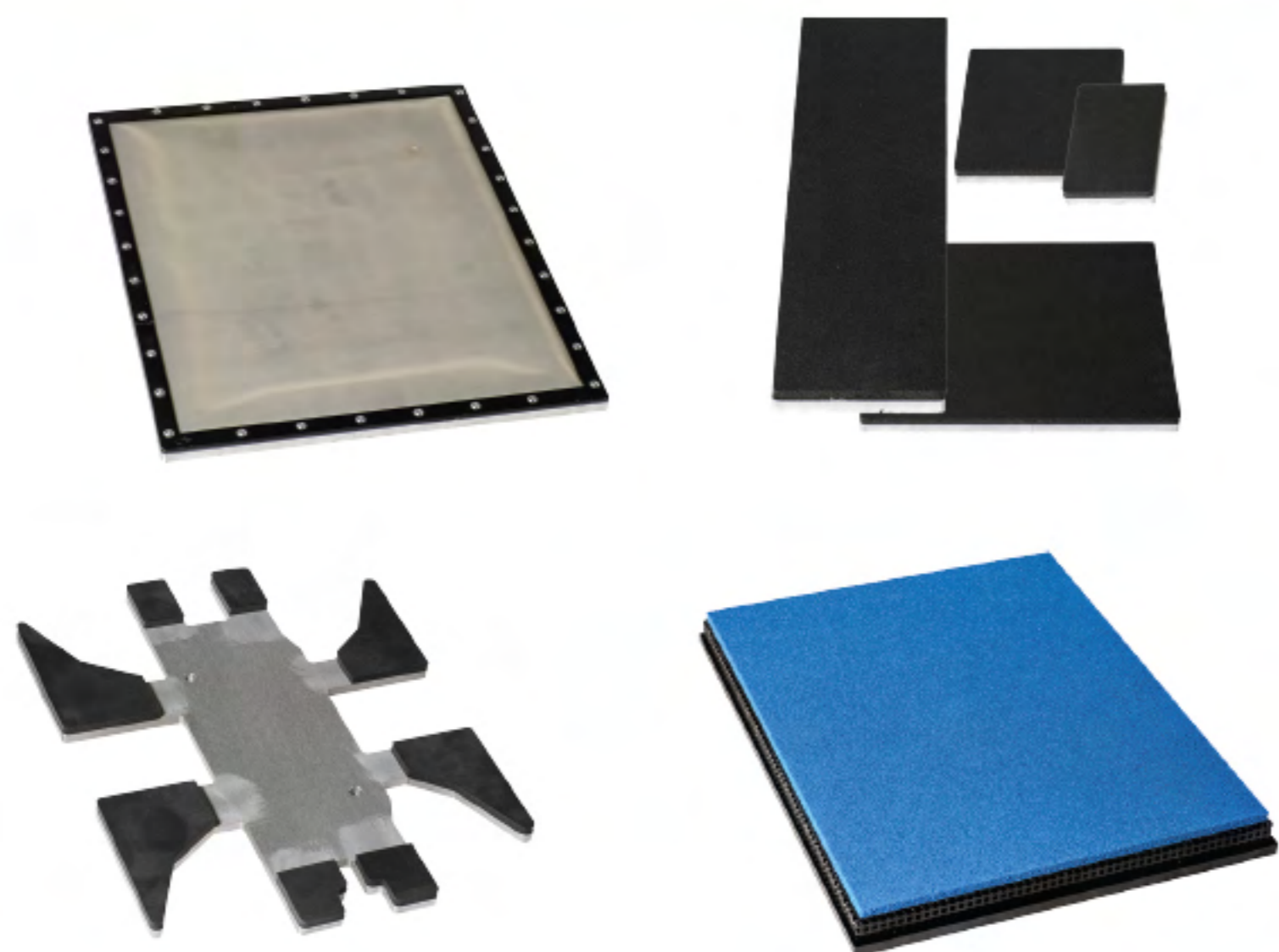

Working Plates

PLA-SET	Set with 48, 49, 50 & 51
PLA-48	15 x 15 cm
PLA-49	12 x 8 cm
PLA-50	25 x 30 cm
PLA-51	12 x 45 cm
PLA-3040	30 x 40 cm
PLA-DRY M	Sponge drying plate 40 x 50 cm
ACC-CHAUD-INF	Heating lower plate 40 x 50 cm
PLA-3035 AIRCLAM	Membrane plate 30 x 35 cm
PLA-SHOES CV	Shoe plate 40 x 50 cm

Support Tables

TAB-98 LITE / R	For all except Duplex and Slide (R for wheels)
TAB-98 PRO / R	For Duplex range (R for wheels)
TABL-98 / R	For Slide models (R for wheels)



Nomex® Covers

HOU-50	For 40 x 50 cm plate
HOU-3040	For 30 x 40 cm plate
HOU-2530	For 25 x 30 cm plate
HOU-1245	For 12 x 45 cm plate
HOU-4555	For 45 x 55 cm plate

Compressors

COMP-37	FOR AIR CLAM X, ROTEX AIR AND LP 130 T
COMP-74	FOR DUPLEX MINI AND SLIDE 865
COMP-111	FOR DUPLEX, SLIDE 1285 AND SUBLI 1510 +
COMP-300	FOR SUBLIMAXI 2513 +



Laser System

CROI-161	For ROTEX series (1 laser)
CROI-160	For DUPLEX series (2 lasers)
CROI-160X4	For DUPLEX series (4 lasers)
LAS-PRO	Additional laser

Large Format Accessories

FEU-XXX	POLYESTER / ARAMID FELT FOR SLIDE & SUBLI
TOI-TXXXX	HEAT PLATE TEFLON COVER FOR SLIDE & SUBLI
TOI-NXXXX	HEAT PLATE NOMEX® COVER FOR SLIDE & SUBLI
PAP-SU-XXX	HD SUBLIMATION PAPER 120 g/m



Sport Accessories

ACC-CAP CB v3	Upper & lower cap accessory for Clam Sport
ACC-CAP US CB v3	Upper & lower US cap accessory for Clam
ACC-SHL CB	Lower logo & shoes accessory for Clam Sport
ACC-BALL v3	Upper & lower ball accessory for Clam Sport
PLA-6 CB v3	Flat heating plate for ball and shoe for Clam Sport
PLA-CB2	Lower ball accessory
ACC-PLA DUPLEX MINI PRO	Logo plate 16 x 16 cm
ACC-CAP DUPLEX MINI PRO	Cap accessory 18 x 8 cm

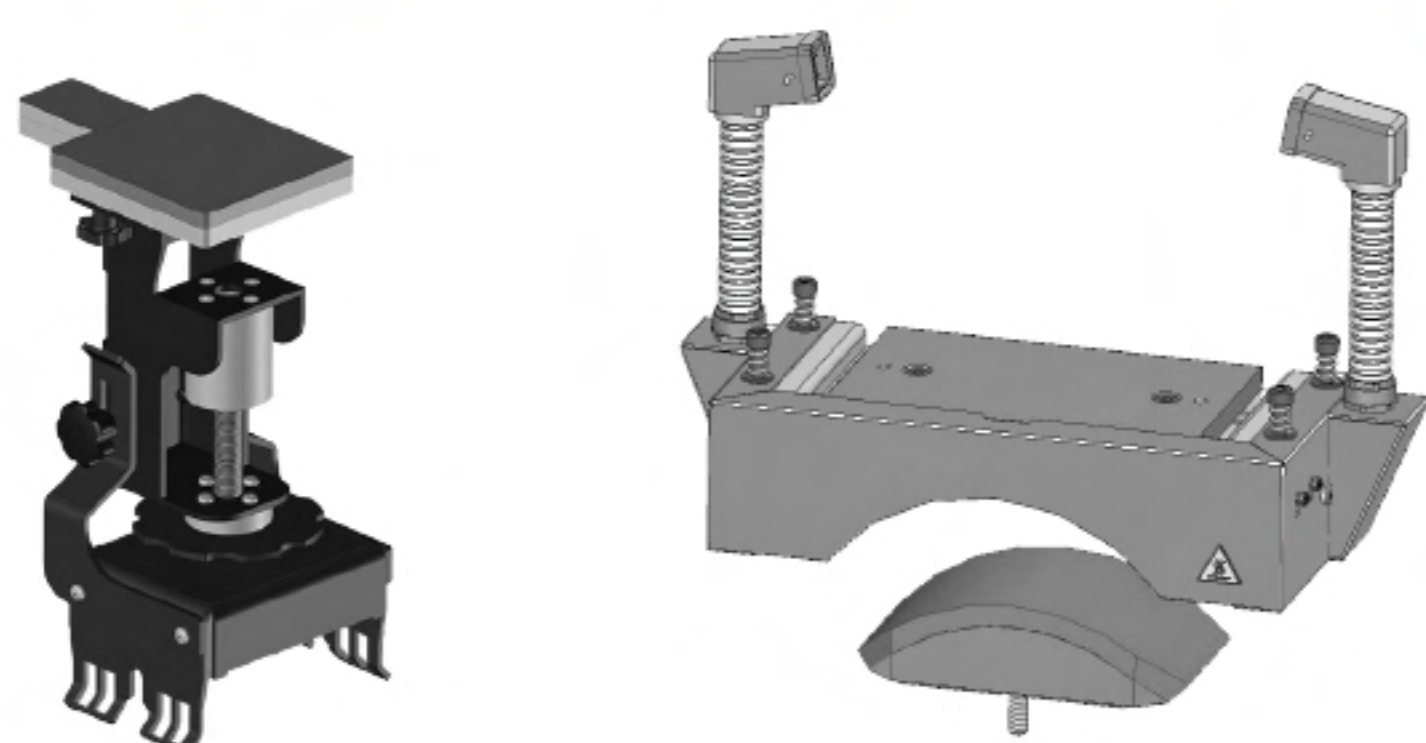

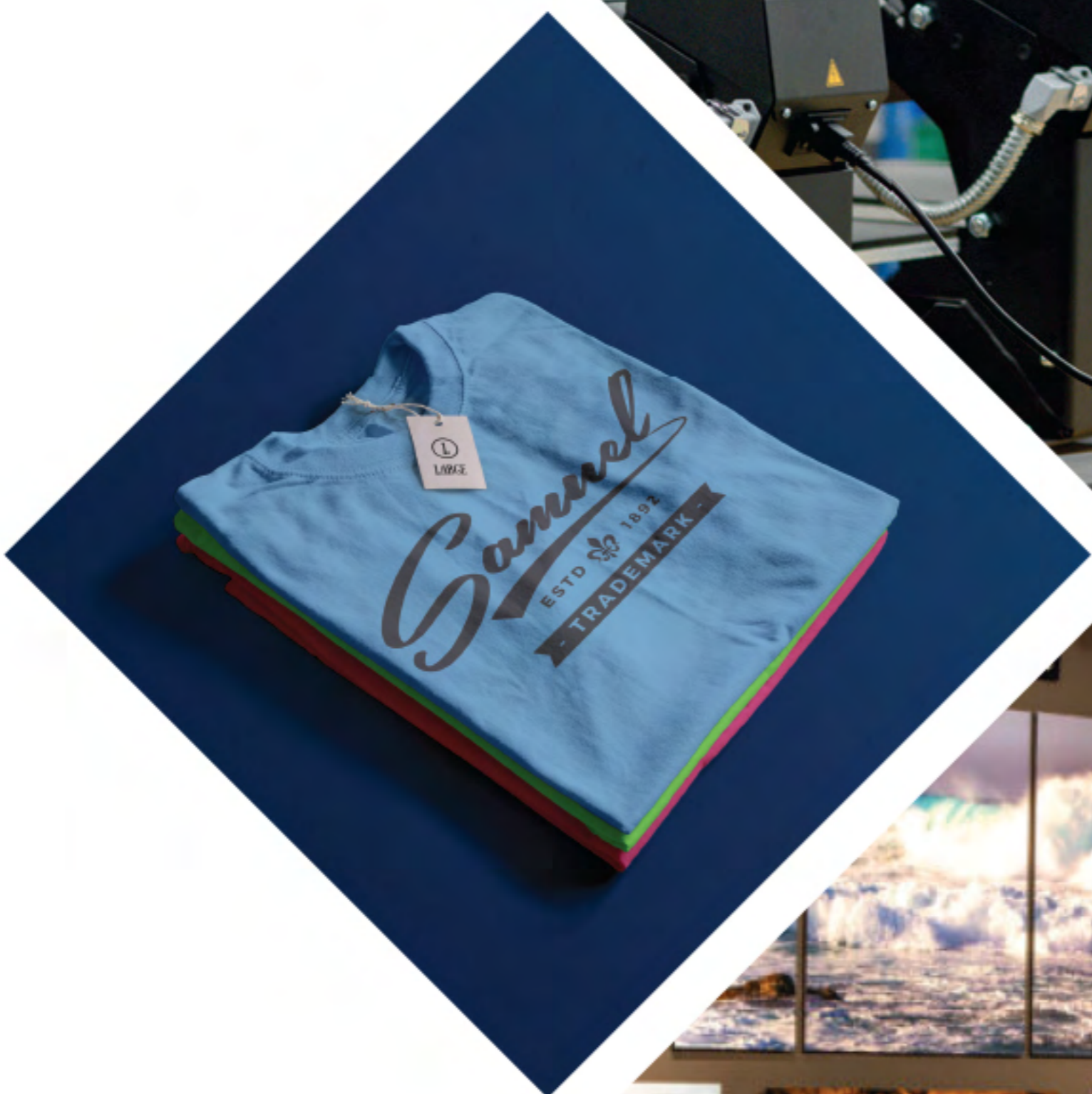



Sefa

HEAT TRANSFER TECHNOLOGIES

Since 1973, Sefa, a French designer and manufacturer of heat transfer presses for the textile industry and sublimation market on solid materials, with an international experience and a recognized quality of products.

WHO WE ARE

Sefa offers standard or personalized solutions to transfer on T-shirts, sporting goods, caps, luggage, cups, mousepads and other items of visual and photographic communication. Our wide range of presses extends from the single-tray manual press for the launch of your activity, to the large format sublimation press for Chromaluxe applications, to the dual plate pneumatic press for higher production rates. More recently, we have come to add to our presses drying solutions for direct printing applications and have now been very well known for our large presses range dedicated to sublimation technology.



Chemica | Stilscreen | Sefa | Elms | TransferID | Sporting ID

FLEXDEV Group is present in the field of textile personalisation / decoration thanks to its different companies: heat transfers for textile – CHEMICA, screen printing heat transfers – STILSCREEN & SPORTING ID, customisation services – ELMS MARKETING, online craft distribution – TRANSFER ID and heat transfer presses with SEFA.

WWW.SEFA.FR



MADE IN FRANCE

High quality manufacturing made in Esperaza, France.



HERE TO HELP

Assistance and support from our multilingual customer service.



QUALITY ACHIEVEMENT

The largest range of quality and innovative products.



WORLDWIDE BUSINESS

Products sold in more than 80 countries.



WORK WITH PASSION

Your full satisfaction drives us through the work we do on each press, day after day.

CONTACT INFORMATION



sales@sefa.fr
support@sefa.fr



+33 (0)4 68 74 05 89



ZI de Pastabrac 11260
Espérasa, France