



# ImagePerfect™ 7700 Styling Window Films

Päästä luovuutesi valloilleen ja somista  
sisätilojen lasipinnat trendikkäillä  
kuvioituilla lasinsomistuskalvoilla

**Spandex** 

inspiring creativity



## IP 7700 kuvioidut ikkunakalvot

ImagePerfect 7700 Styling Window Films -kalvot ovat valmiiksi kuvioituja, tyylikkäästi lasinsomistuskalvoja, joilla voidaan toteuttaa helposti ja nopeasti luovia sisustuksia ja tilauudistuksia sisäikkunoihin ja välioviin.

Monipuolinen, reilut 30 kuosia käsittävä valikoima sisältää erilaisia valkokuviollisia, geometrisiä, aaltokuvioita sekä pysty- ja vaakaviivallisia malleja, jotka piristävät ja somistavat tyylikkäästi mm. neukkareiden, liiketilojen, ravintoloiden ja hotellien lasipintoja.

IP 7700-sarjan ikkunakalvot ovat tilaustuotteita, mutta pystymme toimittamaan ne nopeasti vain noin viikon toimitusajalla tilauksestasi. Minimitilauusmäärä on 3 m / kalvo. Spandexin myynti ja asiakaspalvelu ovat apunasi arkisin klo 8-16 numerossa 010 841 8080 tai sähköpostitse [myynti.fi@spandex.com](mailto:myynti.fi@spandex.com).

# IP 7701 Athens



# IP 7702 Berlin



# IP 7703 Bern



# IP 7704 Chicago



# IP 7705 Doha



# IP 7706 Dublin

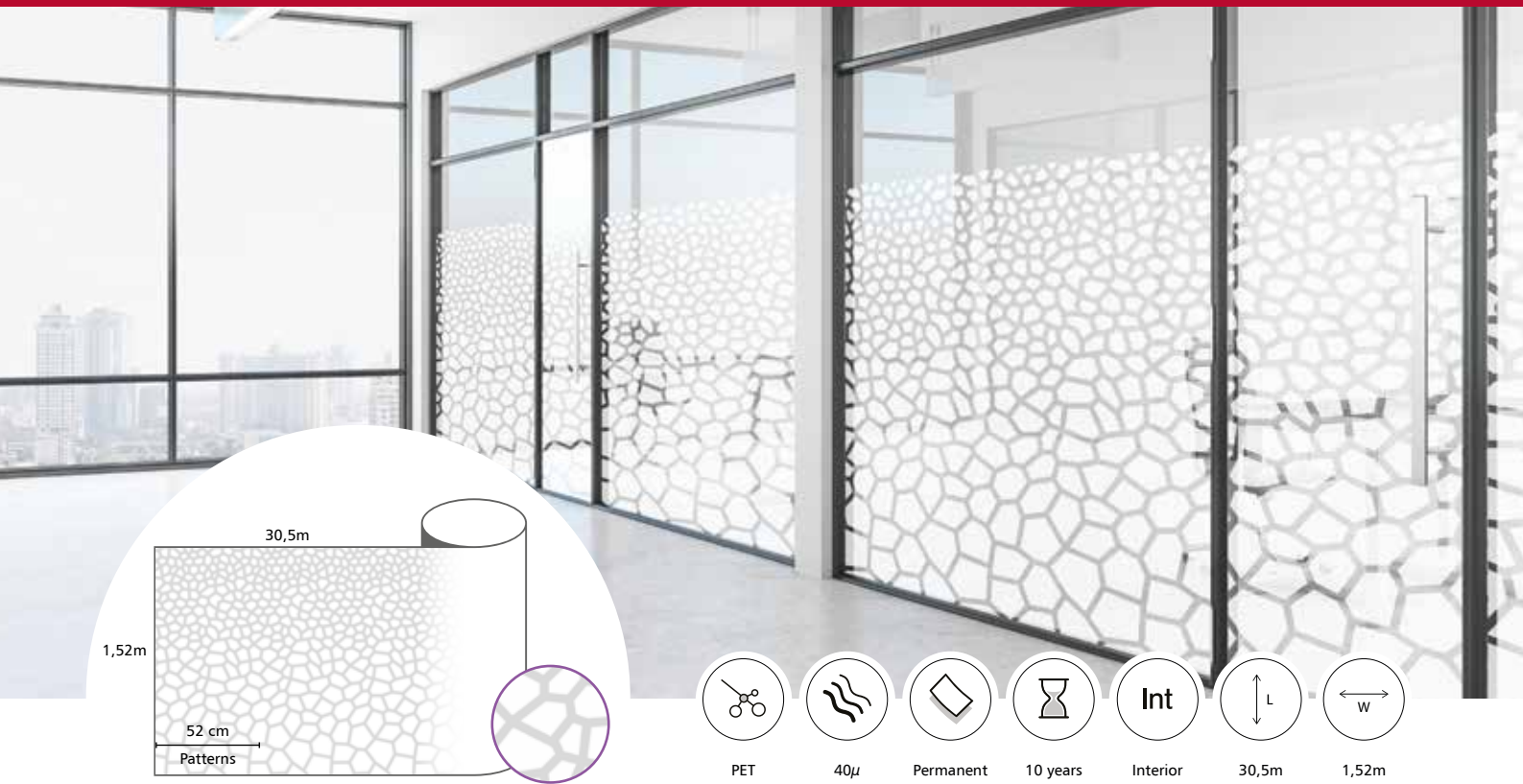

# IP 7707 Edinburgh

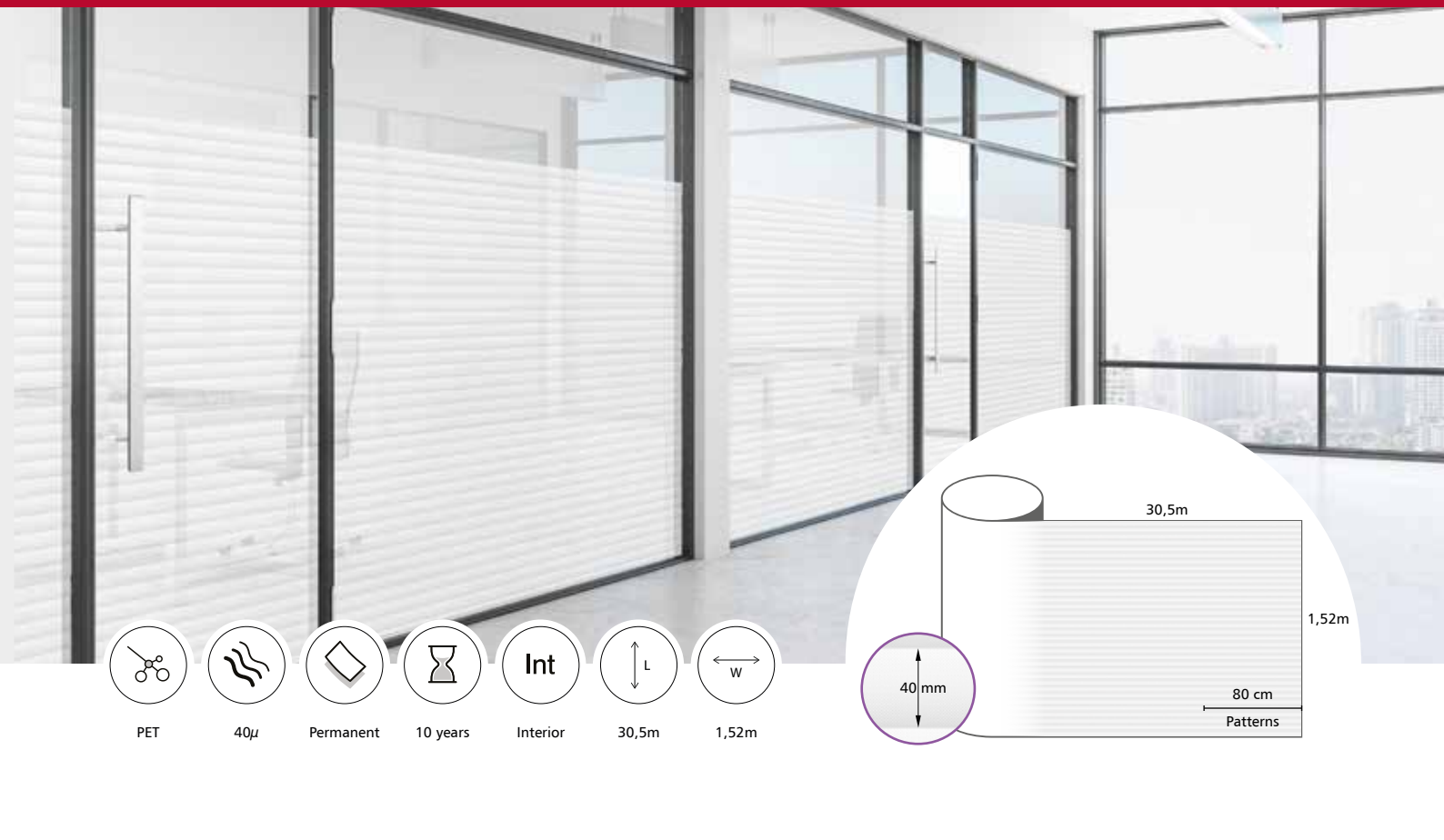

# IP 7708 Florence



# IP 7709 Ghent

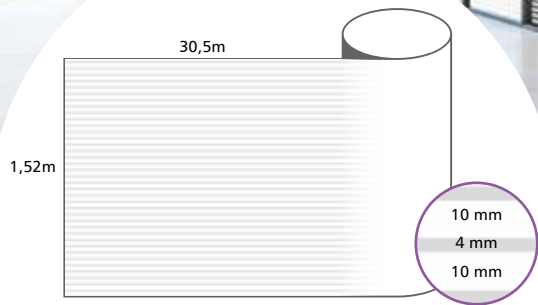

- PET
- 40µ
- Permanent
- 10 years
- Interior
- 30,5m
- 1,52m

# IP 7710 Gibraltar

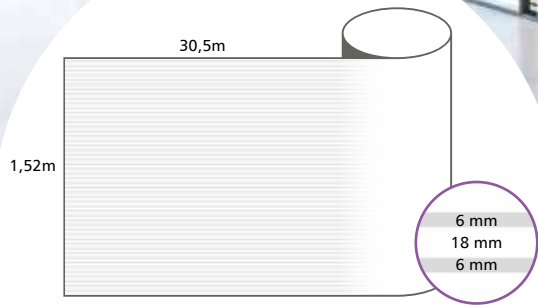

- PET
- 40µ
- Permanent
- 10 years
- Interior
- 30,5m
- 1,52m

# IP 7711 Havana



PET



40µ



Permanent



10 years



Interior



30,5m



1,52m

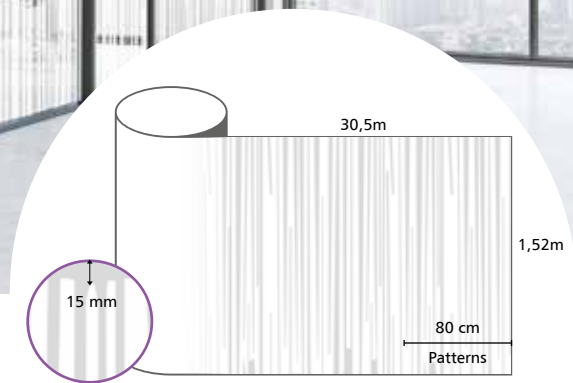

# IP 7712 Helsinki



PET



40µ



Permanent



10 years



Interior



30,5m



1,52m

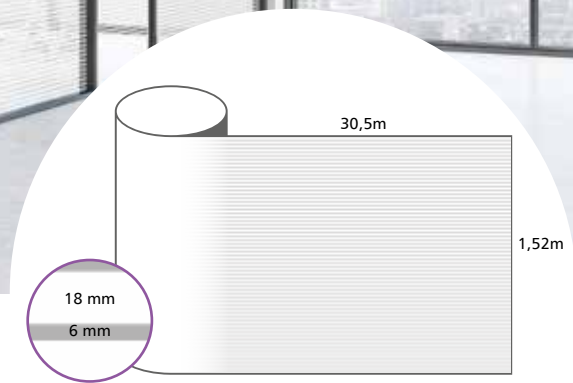



# IP 7713 Jakarta

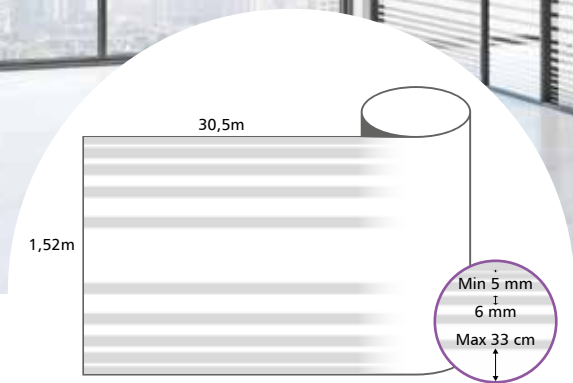

- PET
- 40µ
- Permanent
- 10 years
- Interior
- 30,5m
- 1,52m

# IP 7714 Istanbul

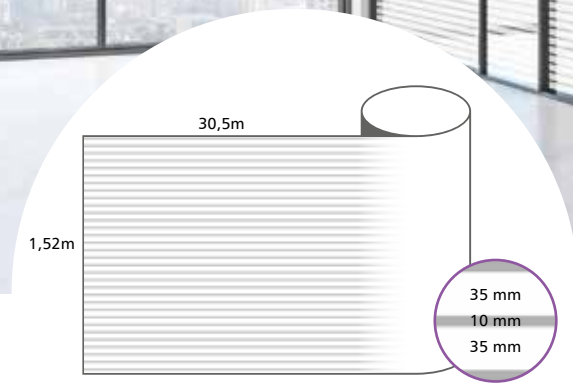

- PET
- 40µ
- Permanent
- 10 years
- Interior
- 30,5m
- 1,52m

# IP 7715 Kiev



PET



40µ



Permanent



10 years



Interior



30,5m



1,52m

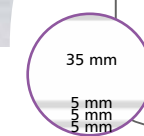

35 mm

5 mm  
5 mm  
5 mm

# IP 7716 Kingston



PET



40µ



Permanent



10 years



Interior



30,5m



1,52m



30,5m

1,52m

80 cm

Patterns

# IP 7717 Kyoto



# IP 7718 Lancaster



# IP 7719 Lisbon



Technical specifications for IP 7719 Lisbon:

- PET
- 40 $\mu$
- Permanent
- 10 years
- Interior
- 30,5m
- 1,52m



30,5m  
1,52m  
50 cm  
Patterns

# IP 7720 London



Technical specifications for IP 7720 London:

- PET
- 40 $\mu$
- Permanent
- 10 years
- Interior
- 30,5m
- 1,52m



30,5m  
1,52m  
72 cm  
Patterns

# IP 7721 Madrid

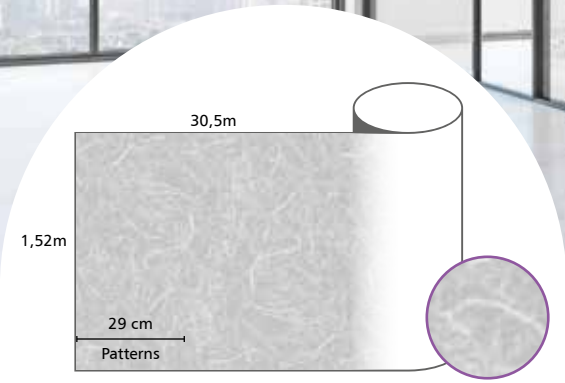

-  PET
-  40μ
-  Permanent
-  10 years
-  Interior
-  30,5m
-  1,52m

# IP 7722 Miami

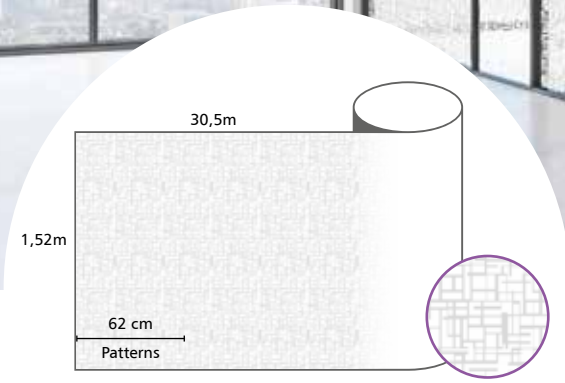

-  PET
-  40μ
-  Permanent
-  10 years
-  Interior
-  30,5m
-  1,52m

# IP 7723 Moscow



# IP 7724 Munich



# IP 7725 Oslo



# IP 7726 Paris



# IP 7727 Prague



-  PET
-  40μ
-  Permanent
-  10 years
-  Interior
-  30,5m
-  1,52m

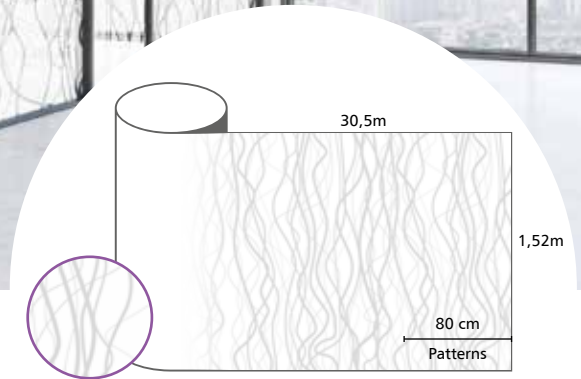

# IP 7728 Riga



-  PET
-  40μ
-  Permanent
-  10 years
-  Interior
-  30,5m
-  1,52m

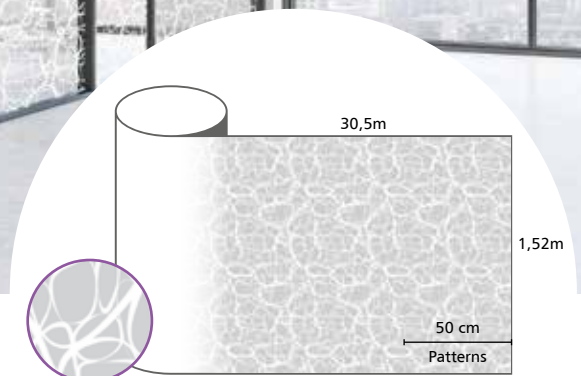



# IP 7729 Rome

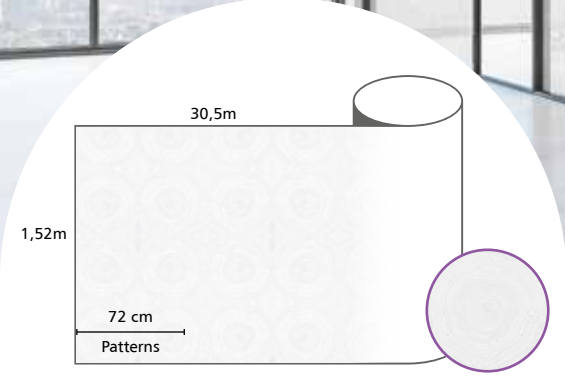

-  PET
-  40 $\mu$
-  Permanent
-  10 years
-  Int
-  30,5m
-  1,52m

# IP 7730 Seattle

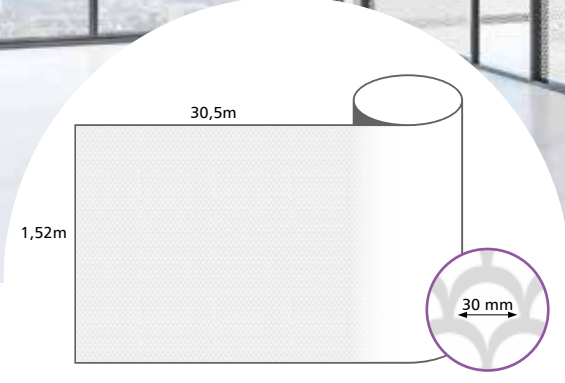

-  PET
-  40 $\mu$
-  Permanent
-  10 years
-  Int
-  30,5m
-  1,52m

# IP 7731 Sydney

**PET**   **40μ**   **Permanent**   **10 years**   **Int**   **30,5m**   **1,52m**

30,5m  
1,52m  
50 cm  
Patterns

# IP 7732 Tokyo

**PET**   **40μ**   **Permanent**   **10 years**   **Int**   **30,5m**   **1,52m**

30,5m  
1,52m  
66 cm  
Patterns

# IP 7733 Vienna

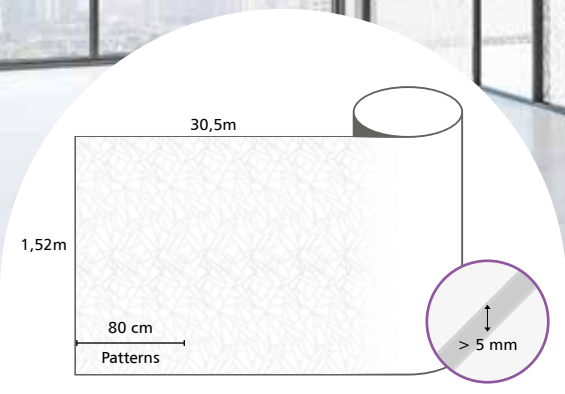
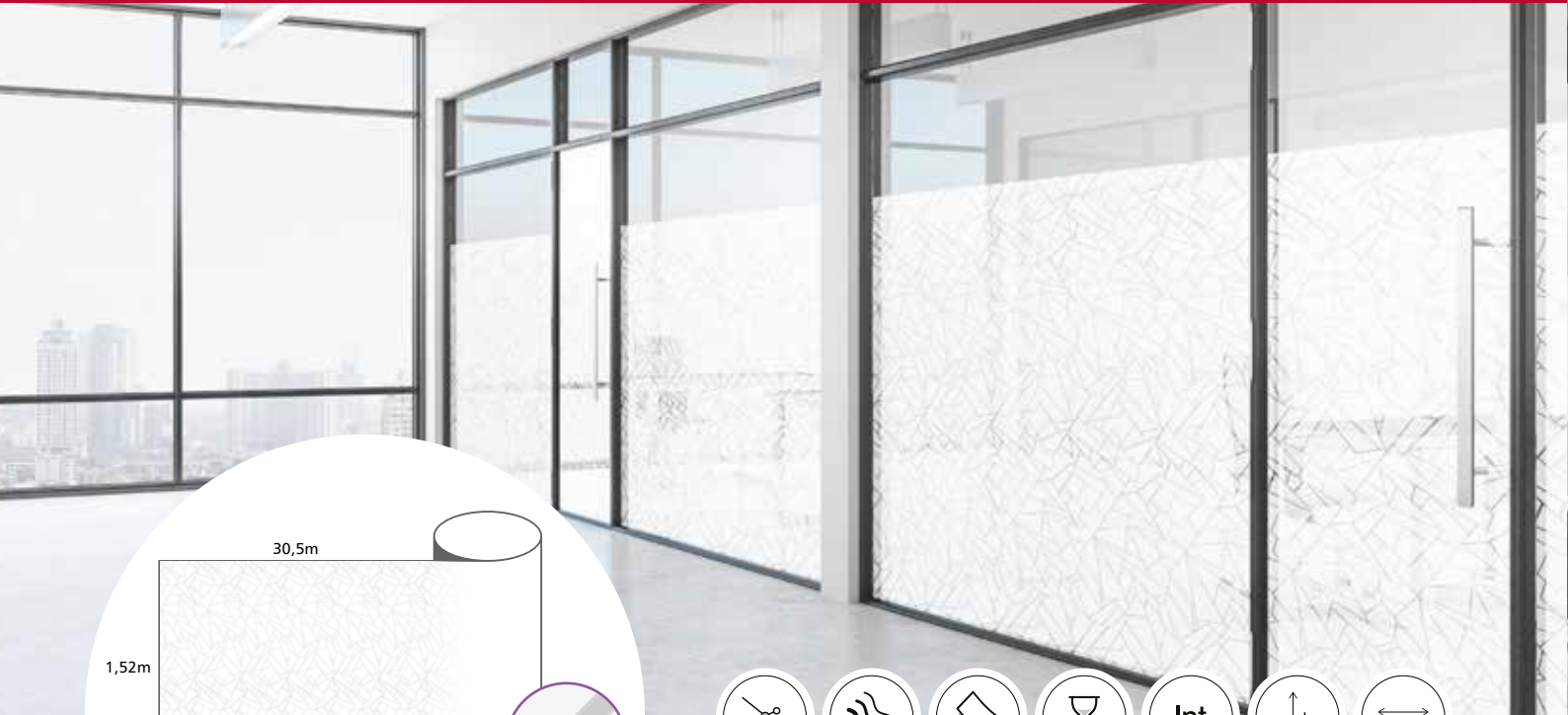

- PET
- 40µ
- Permanent
- 10 years
- Interior
- 30,5m
- 1,52m

# IP 7734 Zurich

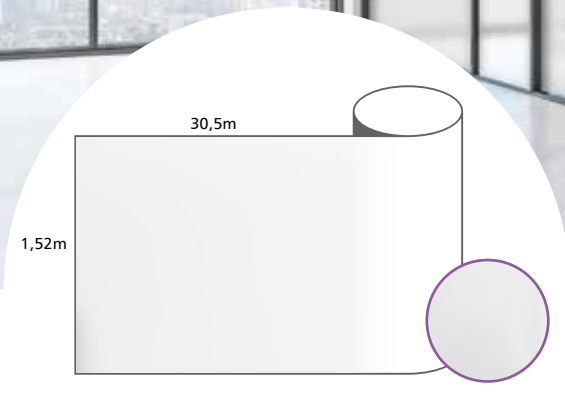

- PET
- 40µ
- Permanent
- 10 years
- Interior
- 30,5m
- 1,22m
- 1,52m
- 1,83m

# IP 7735 Boston



-  PET
-  90µ
-  Permanent
-  5 years
-  Interior
-  30,5m
-  1,52m



- IP 7500 Speciality Window
- IP 7600 Coloured Window
- IP 7700 Styling Window
- IP 7800 Decorative Window



# ImagePerfect™ 7700 Styling Films

**ImagePerfect™ 7700 Styling Films incorporate printed designs for the easy customisation of interior windows and glass panels.**

The ImagePerfect™ 7700 Styling Films utilise a high-quality PET film with a printed design that, when applied to glass, allows for the easy decoration and customisation of interior windows and partition screens, adding originality, character and sophistication. The eye-catching designs include floral patterns, geometric patterns, wave patterns and vertical and horizontal linear patterns. The designs incorporate a range of solid, graduated and granular effects and they will also add an element of privacy screening in a more subtle fashion than would otherwise be the case if a full blackout film was used. As an exception, rather than a printed PET film, IP 7734 Zurich incorporates a thicker PET film with inherent opalescence and it provides a useful alternative to more typical frosted PVC films for decorative window installations. Another exception is the outstanding design of IP 7735 Boston which imitates fluted glass. In All of the films will be used in corporate and commercial environments, such as meetings rooms, conference facilities and lobbies, as well as retail environments and lifestyle business locations, such as spas, salons, gyms, hotels, theatres and restaurants. The films have high optical qualities. They must be wet applied.

Attention: Do not clean for at least 1 month after application and do not apply any type of sticker or adhesive on the film.

| Specifications                       |                                  |                                  |                                  |
|--------------------------------------|----------------------------------|----------------------------------|----------------------------------|
| <b>Product</b>                       | IP 7701-7733                     | IP 7734                          | IP 7735                          |
| <b>Description</b>                   | Polyester                        | Polyester                        | Polyester                        |
| <b>Installation</b>                  | Interior                         | Interior                         | Interior                         |
| <b>Colour from the outside</b>       | White or frosted                 | White or frosted                 | Frosted                          |
| <b>Thickness</b>                     | 40mym                            | 60mym                            | 90mym                            |
| <b>Adhesive</b>                      | Solvent-based acrylic, permanent | Solvent-based acrylic, permanent | Solvent-based acrylic, permanent |
| <b>Durability (unprinted)</b>        | 10 years                         | 10 years                         | 5 years                          |
| <b>Flame Retardancy</b>              | M1                               | M1                               | M1                               |
| <b>Shelf Life (at -5°C to +40°C)</b> | 3 years                          | 3 years                          | 3 years                          |
| <b>End of Life / Disposal</b>        | N/A                              | N/A                              | N/A                              |

© August 2023 Eikon Ltd. Technical specifications are subject to change without prior notice. All trademarks mentioned are the property of their respective owners.

For more information about ImagePerfect please visit [www.imageperfect.com](http://www.imageperfect.com)

Eikon Ltd, 38 Port Royal Avenue, Lune Industrial Estate, Lancaster. United Kingdom

Information on physical and chemical characteristics and values in this document are based upon tests we believe to be reliable and do not constitute a warranty. They are intended only as a source of information and are given without guarantee and do not constitute a warranty. Purchasers should independently determine, prior to use, the suitability of such products for their specific use, including, but not limited to, the application, conditions, maintenance, and the Purchaser shall assume all risk and liability of every nature in connection therewith. All technical data are subject to change without prior notice. In case of any ambiguities or differences between the English and foreign versions of this document, the English version shall be prevailing and leading.

Eikon gives no express or implied guarantees or warranties with respect to the Products, including, but not limited to, any implied warranties of fitness for any particular use and/or non-infringement. All products are sold subject to Eikon's general terms and conditions of sale. Eikon's aggregate liability, whether for negligence, breach of contract, misrepresentation or otherwise, shall in no circumstances exceed the price of the defective, non-conforming, damaged or undelivered Products which give rise to such liability as determined by net price invoiced to Purchaser in respect of any occurrence or series of occurrences. In the event of improper use and/or incorrect processing that does not comply with our instructions, any and all liability is excluded. In no circumstances shall Eikon be liable for any indirect, incidental or consequential loss, damage or injury, including without limitation, loss of anticipated profits, goodwill, reputation, or losses or expenses resulting from third party claims.

## Spandex maailmalla

Australia  
Austria  
Belgium  
Czech Republic  
Estonia  
Finland  
France  
Germany  
Italy  
Norway  
Portugal  
Slovakia  
Spain  
Sweden  
Switzerland  
The Netherlands  
Turkey  
United Kingdom  
United States

---

Spandex Headquarters  
Aegertweg 4  
8305 Dietlikon  
Switzerland  
[www.spandex.com](http://www.spandex.com)

### Spandex Finland Oy

Jusslansuora 15, 04360 Tuusula



[www.spandex.fi](http://www.spandex.fi)



[www.spandex.fi](http://www.spandex.fi)



+358 (0)10 841 8080 Email: [myynti.fi@spandex.com](mailto:myynti.fi@spandex.com)



[/spandexfinland](https://www.facebook.com/spandexfinland)



[@spandexfinland](https://www.instagram.com/spandexfinland)



[Spandexcom](https://www.youtube.com/Spandexcom)



[/company/spandexfinland](https://www.linkedin.com/company/spandexfinland)